

SFM4100 Series

Low-cost Digital Mass Flow Meter for Gases

- Accuracy 3% m.v.
- Digital output (I²C)
- Multigas option available
- Calibrated and temperature compensated
- Excellent long-term stability
- Downmount or legris carstick fittings



Product Summary

The SFM4100 gas flow meter series is designed as a versatile OEM gas flow meter for demanding volume applications.

The SFM4100 is designed to measure **Air and non-aggressive gases** with excellent accuracy over a large dynamic range. **Mass flows ranges up to 20 slm** are available. The SFM4100 series operates with supply voltage 5-9 VDC and through its digital I²C interface it can be easily embedded into a microprocessor environment. The sturdy design of the SFM4100 sensor allows for **operation pressures up to 10 barg**. The flow signal is internally **linearized and temperature compensated**.

The outstanding performance of these sensors is based on Sensirion's **patented CMOSens[®] sensor technology**, which combines the sensor element, signal processing and digital calibration on a single microchip. The mass flow is measured by a thermal method on the MEMS sensor element. Compared to other thermal mass flow sensors (MEMS, hotwire or capillary type) the SFM4100 features an **extended dynamic range**, higher **long-term stability**, and improved repeatability.

The well-proven CMOS technology is perfectly suited for high-quality mass production and is the ideal choice for **demanding and cost-sensitive OEM applications**.

Applications

- Medical (e.g. respiratory care, anesthesia)
- Analytical Instruments
- Leak testing
- Process automation

Connection diagram



SFM4100 series with bidirectional digital communication (I²C bus)

Sensor chip

The SFM4100 series features a fourth-generation silicon sensor chip called SF04. In addition to a thermal mass flow sensor element, the chip contains an amplifier, A/D converter, EEPROM memory, digital signal processing circuitry, and interface. The highly sensitive chip is particularly sensitive at lowest flows, giving the SFM4100 sensor its large dynamic range.

SFM4100 OEM options

A variety of custom options such as other analog output, different gases, flow ranges, multigas calibration can be implemented for high-volume OEM applications (>1000pc/y). Ask us for more information.

1. Sensor Performance

1.1 Physical specifications

Parameter ¹	SFM4100
Measurement range	0-20 slm ²
Calibration available	Air, N ₂ , O ₂ , N ₂ O, Ar or CO ₂
Resolution	12 bits preset (for 9–16 bits see documentation)
Zero point accuracy ^{3,4}	0.03 slm
Accuracy ^{3,4}	0.15% of full scale or 3% of reading, whichever is bigger
Span repeatability	0.25% of reading or 5 sccm whichever is bigger
Offset shift due to temperature variation	2 sccm / °C
Span shift due to temperature variation	< 0.1% of reading per °C
Offset stability	< 0.01 slm/year
Pressure drop at full flow	<25mbar
Response time	4.6 ms @ 12-bit resolution (See documentation for response times with other resolutions, e.g. 1.3 ms with 10 bits)
Warm-up time for first reliable measurement	Max. 500ms in general 50 ms

¹ Unless otherwise noted, all sensor specifications are at 23°C and absolute pressure = 4,8 bar.

² Reference conditions for standard liters per minute slm: 20°C, 1013mbar; sccm denotes standard cubic centimeters per minute

³ includes repeatability and hysteresis.

⁴ The zero-point accuracy and span accuracy are independent uncertainties and add according to the principles of error propagation.

1.2 Ambient conditions

Parameter	SFM4100 Series
Media compatibility ⁵	Noncorrosive gases and gas mixtures
Limited media compatibility	corrosive Gases ⁶
Calibrated temperature range ⁵	0 °C to +50 °C
Operating temperature	-20 °C to +80 °C
Storage temperature ⁵	-40 °C to +80 °C
Operating Pressure Range	0-6 bar gauge
Position sensitivity	Use flow horizontally, electronic connector up

⁵ Contact Sensirion for information about other gases, wider calibrated temperature ranges and higher storage temperatures.

⁶ For a limited time period, depending on chemical. Not recommended.

1.3 Materials

Parameter	SFM4100 Series
Wetted materials	Si, Si ₃ N ₄ , SiOx, Gold, Viton [®] , Epoxy, PA-12, Stainless Steel, Nickel Plated Brass, Nylon, Nitrile, coated Aluminium, Oxygenoex
RoHS	fully RoHS compliant

2. Electrical Specifications

2.1 Power supply

The SFM4100 series sensors require a supply voltage (VDD) between 3.5V and 9 V. For the power supply of the level shifter (VLS) a voltage between 2.9V and 5.5V is required. Please be aware that the VLS must be the same as the voltage of SCK.

2.2 Electrical characteristics

Parameter	SFM4100
Supply voltage	3.5 – 9.0 VDD
Level Shifter Supply ⁷	2.9 -5.5 VLS
Current drain	< 12.5 mA typical in operation
Interface	Digital 2-wire interface (I ² C)
Bus clock frequency	SCL: 100 kHz typical
Default I ² C address per gas type	Air: 1 (000001) O ₂ : 2 (000010) CO ₂ : 3 (000011) N ₂ O: 4 (0000100) Ar: 5 (0000101)
Flow output signal	Flow in sccm = value received * 1 Flow in slm = value received / 1000

⁷ Same voltage as the communication level of the µP is required.

3. Interface Specifications

The serial interface of the SFM4100 series is optimized in terms of sensor readout and power consumption. It is compatible with I²C interfaces. For detailed specifications of the I²C protocol, see *The I²C Bus Specification*, Version 2.1, January 2000 (source: NXP).

(www.nxp.com/products/interface_control/i2c)

3.1 Interface connection – external components

Bi-directional bus lines are implemented by the devices (master and slave) using open-drain output stages and a pull-up resistor connected to the positive supply voltage.

The recommended pull-up resistor value depends on the system setup (capacitance of the circuit or cable and bus clock frequency). In most cases, 10 kΩ is a reasonable choice.

The capacitive loads on SDA and SCL line have to be the same. It is important to avoid asymmetric capacitive loads.



3.2 I²C Address

The I²C address consists of a 7-digit binary value. By default, the I²C address of the SFM4100 is gas specific (see chapter 2.2). The address is always followed by a write bit (0) or read bit (1).

3.3 Transfer sequences

Transmission START Condition (S): The START condition is a unique situation on the bus created by the master, indicating to the slaves the beginning of a transmission sequence (the bus is considered busy after a START).

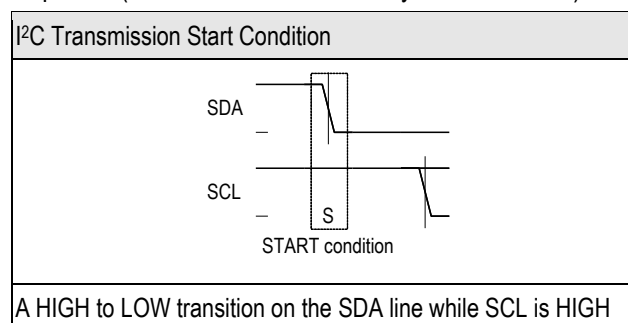

Transmission STOP Condition (P): The STOP condition is a unique situation on the bus created by the master, indicating to the slaves the end of a transmission sequence (the bus is considered free after a STOP).



Acknowledge (ACK) / Not Acknowledge (NACK): Each byte (8 bits) transmitted over the I²C bus is followed by an acknowledge condition from the receiver. This means that after the master pulls SCL low to complete the transmission of the 8th bit, SDA will be pulled low by the receiver during the 9th bit time. If after transmission of the 8th bit the receiver does not pull the SDA line low, this is considered to be a NACK condition.

If an ACK is missing during a slave to master transmission, the slave aborts the transmission and goes into idle mode.



Handshake procedure (Hold Master): In a master-slave system, the master dictates when the slaves will receive or transmit data. However, in some situations a slave device may need time to store received data or prepare data to be transmitted. Therefore, a handshake procedure is required to allow the slave to indicate termination of internal processing.

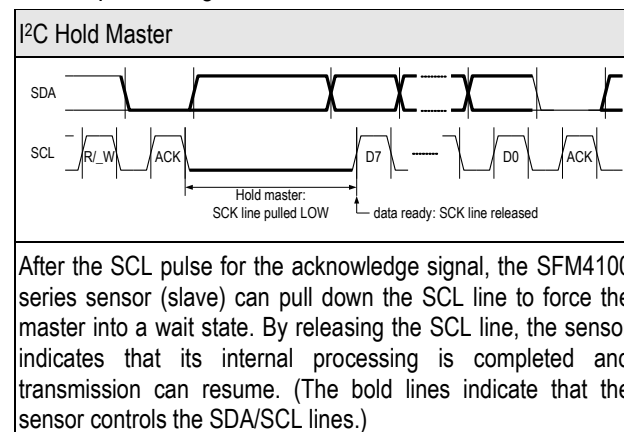

3.4 Data transfer format

Data is transferred in byte packets in the I²C protocol, which means in 8-bit frames. Each byte is followed by an acknowledge bit. Data is transferred with the most significant bit (MSB) first.

A data transfer sequence is initiated by the master generating the Start condition (S) and sending a header byte. The I²C header consists of the 7-bit I²C device address and the data direction bit (R/_W).

The value of the R/_W bit in the header determines the data direction for the rest of the data transfer sequence. If R/_W = 0 (WRITE) the direction remains master-to-slave, while if R/_W = 1 (READ) the direction changes to slave-to-master after the header byte.

4. Command Set and Data Transfer Sequences

A command is represented by an 8-bit command code. The data direction may not change after the command byte, since the R/_W bit of the preceding I²C header has already determined the direction to be master-to-slave. In order to execute commands in Read mode using I²C, the following principle is used. On successful (acknowledged) receipt of a command byte, the sensor stores the command nibble internally. The Read mode of this command is then invoked by initiating an I²C data transfer sequence with R/_W = 1.

If a correctly addressed sensor recognizes a valid command and access to this command is granted, it responds by pulling down the SDA line during the subsequent SCL pulse for the acknowledge signal (ACK). Otherwise it leaves the SDA line unasserted (NACK).

The two most important commands are described in this data sheet, and the data transfer sequences are specified. Contact Sensirion for advanced sensor options.

4.1 Measurement triggering

Each individual measurement is triggered by a separate read operation.

Note that two transfer sequences are needed to perform a measurement. First write command byte hF1 (trigger measurement) to the sensor, and then execute a read operation to trigger the measurement and retrieve the flow or differential pressure information.

On receipt of a header with R/_W=1, the sensor generates the Hold Master condition on the bus until the first measurement is completed (see Section 3.3 for timing). After the Hold Master condition is released, the master can read the result as two consecutive bytes. A CRC byte follows if the master continues clocking the SCL line after

the second result byte. The sensor checks whether the master sends an acknowledge after each byte and aborts the transmission if it does not.



4.2 Soft reset

This forces a sensor reset without switching the power off and on again. On receipt of this command, the sensor reinitializes the control/status register contents from the EEPROM and starts operating according to these settings.



4.3 CRC-8 Redundant Data Transmission

Cyclic redundancy checking (CRC) is a popular technique used for error detection in data transmission. The transmitter appends an n-bit checksum to the actual data sequence. The checksum holds redundant information about the data sequence and allows the receiver to detect transmission errors. The computed checksum can be regarded as the remainder of a polynomial division, where the dividend is the binary polynomial defined by the data sequence and the divisor is a “generator polynomial”.

The SF04 sensor implements the CRC-8 standard based on the generator polynomial

$$x^8 + x^5 + x^4 + 1.$$

Note that CRC protection is only used for data transmitted from the slave to the master.

For details regarding cyclic redundancy checking, please refer to the relevant literature.

5. Conversion to Physical Values

5.1 Signal scaling and physical unit

The calibrated signal read from the sensor is a signed INTEGER number (two's complement number). The INTEGER value can be converted to the physical value by dividing it by the scale factor (mass flow = sensor output ÷ scale factor). The scale factor is specified in Section 2.2.

5.2 Temperature compensation

The SFM4100 sensor series features digital temperature compensation. The temperature is measured on the CMOSens® chip by an on-chip temperature sensor. This data is fed to a compensation circuit that is also integrated on the CMOSens® sensor chip. No external temperature compensation is necessary.

6. OEM Options

A variety of custom options can potentially be implemented for high-volume OEM applications. *None of these options is available with the standard sensors.* Contact Sensirion for more information.

6.1 Switch function

A switch version with a programmable trigger level and programmable hysteresis can be realized.

6.2 Temperature measurement

The sensor temperature can be read out via the digital interface.

6.3 Minimized power consumption

For low-power applications, the current consumption can be reduced to approximately 3.5mA.

6.4 Broken sensor element detection

Breakage of the sensor element can be detected by a sensor chip self-test.

6.5 Plausibility checks

An OEM version of the sensor can be configured to provide certain plausibility checks triggered by a microprocessor. This can be used to create a combined sensor/microprocessor system that can be certified as fail-safe.

6.6 Multigas / Multirange Option

The Sensor can be calibrated for the use with multiple Gases and/or for multiple flow ranges.

6.7 Gas Mixture Detection

In combination with an external microprocessor the Sensor can be used to also assess the concentration of many two gas mixtures. This feature can be made available for high volume applications. Please contact Sensirion for details.

6.8 Customer-specific interface

For analog voltage output, please contact Sensirion.

7. Mechanical Specifications

7.1 Mechanical concept

The SFM4100 Series is designed for both through-hole technology hand-soldered to a PCB or downmount configuration for mounting on the manifold.

For mounting on a basis plate 4 screw holes ($\varnothing=3.42\text{mm}$) are available (see Figure 1: position 0/0).

The flow connection is realized with Legris carstick 6mm quick connectors, and thus standard-size plastic tubes (OD 6 mm) are best used.

7.2 Mechanical characteristics

Parameter	
Flow connector	Legris Carstick 6mm / Downmount
Electrical connector	E-Tec: SL2-008-SH108/01-55B or Samtec: HTSW-104-07-6.D
Allowable overpressure	10 bar
Rated burst pressure	> 20 bar
Weight	< 60 g

7.3 SFM4100 – Physical Dimensions

Figure 1: Straight-through flow channel geometry (all dimensions are in mm)



Figure 2: Downmount version with 90° angle (all dimensions are in mm)



7.4 Pin Layout

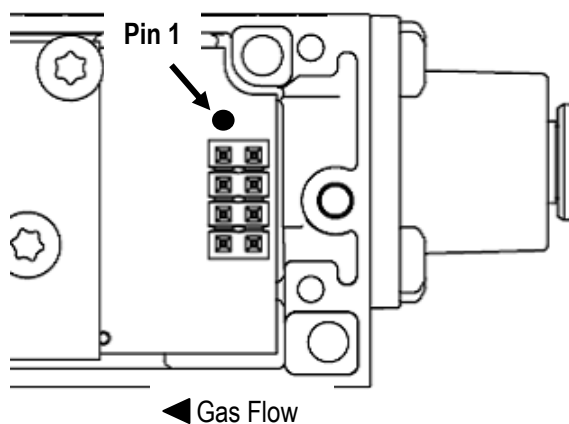

Figure 3: Pin Layout SFM4100

7.5 Pin assignments



Figure 4: Digital output pin assignments (top view)

Pin Number	Definition
Pin 1	Sensor Supply voltage VDD: 3.5-9 V
Pin 2	Not connected
Pin 3	Level shifter supply voltage VLS: 2.9-5.5 V
Pin 4	GND
Pin 5	Bus Clock Line SCL: 10-120 kHz
Pin 6	GND
Pin 7	Data Line / SCK
Pin 8	GND

7.6 Electrical Connection

The SFM4100 Sensor has a 8 pin 2.54 mm pitch electrical connector (E-Tec: SL2-008-SH108/01-55B).

The following connectors can be used as corresponding sockets :

for direct PCB mounting of the SFM4100

Through Hole: Digikey: S7107-ND

SMD: Digikey: S5713-ND

with ribbon cable connector

Digikey: 609-3568-ND

Mouser: 649-71600-008LF

corresponding ribbon cable

Mouser: 517-3365/08-300SF

Farnell: 9187111

The cable length from the sensor to the microprocessor is recommended to be below 30 cm. In case longer cable length is required, please contact Sensirion.

7.7 Sensor handling

The sensors of the SFM4100 series are designed to be robust and vibration resistant. Nevertheless, the accuracy of the high-precision SFM4100 series can be degraded by rough handling. Sensirion does not guarantee proper operation in case of improper handling. **Note:** avoid

applying any mechanical stress to the solder joints of the sensor during or as a result of PCB assembly.

The sensor ships in an antistatic package to prevent electrostatic discharge (ESD), which can damage the part. To avoid such damage, ground yourself using a grounding strap or by touching a grounded object. Furthermore store the parts in the antistatic package when not in use.

7.8 Packaging, Labeling

Housing: The sensor housing consists of Grillamid (PA12). The device is fully RoHS compliant – it is free of Pb, Cd, Hg, Cr(6+), PBB and PBDE.

Each sensor is labelled on the front side:

Traceability Information: SFM4xxx are shipped in trays of 10pcs with 4 trays per box. The tray dimension is 355mm x 255mm x 21.5mm. Each Sensor is traceable through its unique serial number.

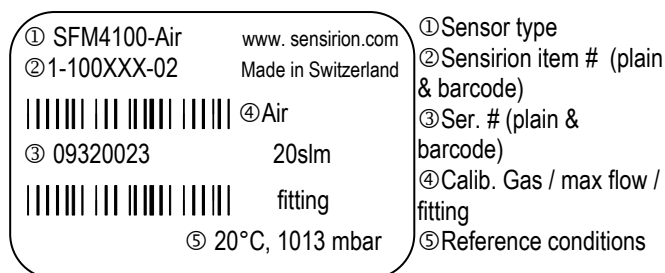

Figure 5: Label sticking on each sensor

8. Ordering Information

Use the part names and item numbers shown in the following table when ordering SFM4100 series mass flow sensors. For the latest product information and local distributors, visit www.sensirion.com.

Part name	Gas	Calibrated range	Item number	
			Legris	Downmount
SFM4100	Air, N ₂	0-20 slm	1-100688-02	1-100890-02
SFM4100	O ₂	0-20 slm	1-100686-02	1-100888-02
SFM4100	CO ₂	0-20 slm	1-100687-02	1-100889-02
SFM4100	N ₂ O	0-20 slm	1-100684-02	1-100886-02
SFM4100	Ar	0-20 slm	1-100685-02	1-100887-02
SFM7xxx	OEM	OEM	tbd	

Packaging units: 10 items/tray and 40 items/box.

MOQ: 1 box = 40 Sensors of the same type.

9. Safety Precautions

Do not use this product as safety or emergency stop device or in any other application where failure of the product could result in personal injury. Failure to comply with these instructions could result in death or serious injury.

Important Notices

Warning, personal injury

Do not use this product as safety or emergency stop devices or in any other application where failure of the product could result in personal injury (including death). Do not use this product for applications other than its intended and authorized use. Before installing, handling, using or servicing this product, please consult the datasheet and application notes. Failure to comply with these instructions could result in death or serious injury.

If the Buyer shall purchase or use SENSIRION products for any unintended or unauthorized application, Buyer shall defend, indemnify and hold harmless SENSIRION and its officers, employees, subsidiaries, affiliates and distributors against all claims, costs, damages and expenses, and reasonable attorney fees arising out of, directly or indirectly, any claim of personal injury or death associated with such unintended or unauthorized use, even if SENSIRION shall be allegedly negligent with respect to the design or the manufacture of the product.

ESD Precautions

The inherent design of this component causes it to be sensitive to electrostatic discharge (ESD). To prevent ESD-induced damage and/or degradation, take customary and statutory ESD precautions when handling this product.

Warranty

SENSIRION warrants solely to the original purchaser of this product for a period of 12 months (one year) from the date of delivery that this product shall be of the quality, material and workmanship defined in SENSIRION's published specifications of the product. Within such period, if proven to be defective, SENSIRION shall repair and/or replace this product, in SENSIRION's discretion, free of charge to the Buyer, provided that:

- notice in writing describing the defects shall be given to SENSIRION within fourteen (14) days after their appearance;
- such defects shall be found, to SENSIRION's reasonable satisfaction, to have arisen from SENSIRION's faulty design, material, or workmanship;
- the defective product shall be returned to SENSIRION's factory at the Buyer's expense; and
- the warranty period for any repaired or replaced product shall be limited to the unexpired portion of the original period.

This warranty does not apply to any equipment which has not been installed and used within the specifications recommended by SENSIRION for the intended and proper use of the equipment.

10. Revision history

Date	Version	Changes
September 2009	V1.0	Initial release
June 2010	V1.1	Correction of I2C address
September 2010	V1.2	Several corrections
January 2013	V1.3	Item number update, manifold version added, improved accuracy, other corrections

EXCEPT FOR THE WARRANTIES EXPRESSLY SET FORTH HEREIN, SENSIRION MAKES NO WARRANTIES, EITHER EXPRESS OR IMPLIED, WITH RESPECT TO THE PRODUCT. ANY AND ALL WARRANTIES, INCLUDING WITHOUT LIMITATION, WARRANTIES OF MERCHANTABILITY OR FITNESS FOR A PARTICULAR PURPOSE, ARE EXPRESSLY EXCLUDED AND DECLINED.

SENSIRION is only liable for defects of this product arising under the conditions of operation provided for in the datasheet and proper use of the goods. SENSIRION explicitly disclaims all warranties, express or implied, for any period during which the goods are operated or stored not in accordance with the technical specifications.

SENSIRION does not assume any liability arising out of any application or use of any product or circuit and specifically disclaims any and all liability, including without limitation consequential or incidental damages. All operating parameters, including without limitation recommended parameters, must be validated for each customer's applications by customer's technical experts. Recommended parameters can and do vary in different applications.

SENSIRION reserves the right, without further notice, (i) to change the product specifications and/or the information in this document and (ii) to improve reliability, functions and design of this product.

Copyright© 2001-2009, SENSIRION.
CMOSens® is a trademark of Sensirion
All rights reserved

RoHS and WEEE Statement

The SFM4100 Series complies with requirements of the following directives:

- EU Directive 2002/96/EC on waste electrical and electronic equipment (WEEE), OJ13.02.2003; esp. its Article 6 (1) with Annex II.
- EU Directive 2002/95/EC on the restriction of the use of certain hazardous substances in electrical and electronic equipment (RoHS), OJ 13.02.2003; esp. its Article 4.

